

179079-15  
179080-15

*Vi anbefaler at være to personer til samling af dette produkt.  
Wir empfehlen, dass die Montage des Produktes von zwei  
Personen durchgeführt wird.  
Vi rekommenderar att man är två personer för montering av  
produkten.  
Nous vous recommandons d'être à deux pour procéder à  
l'assemblage du produit.*

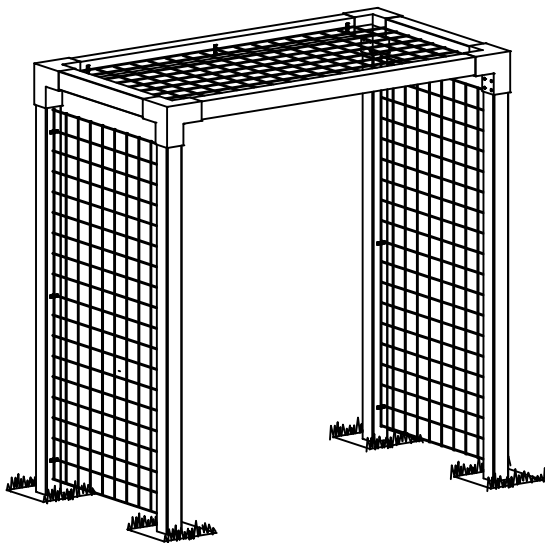

179079-15

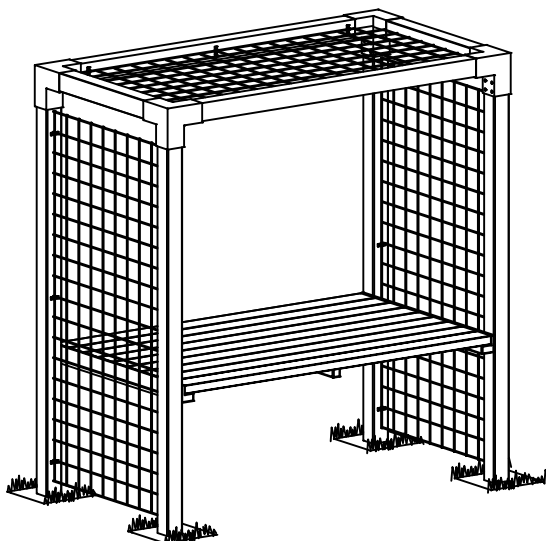
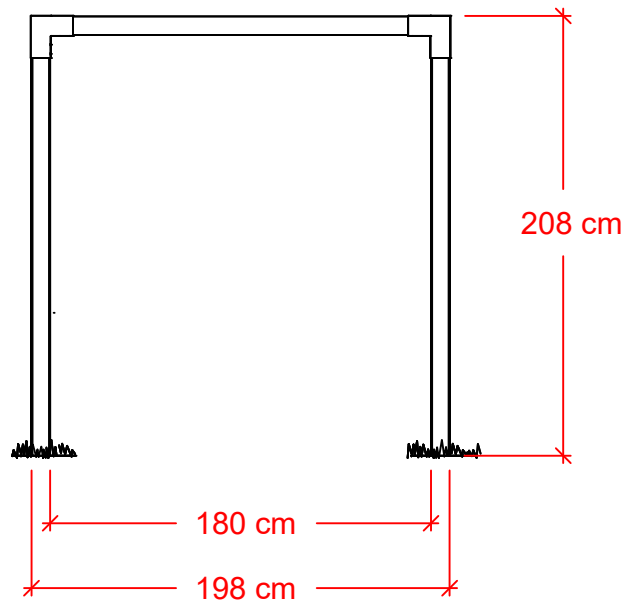

179080-15

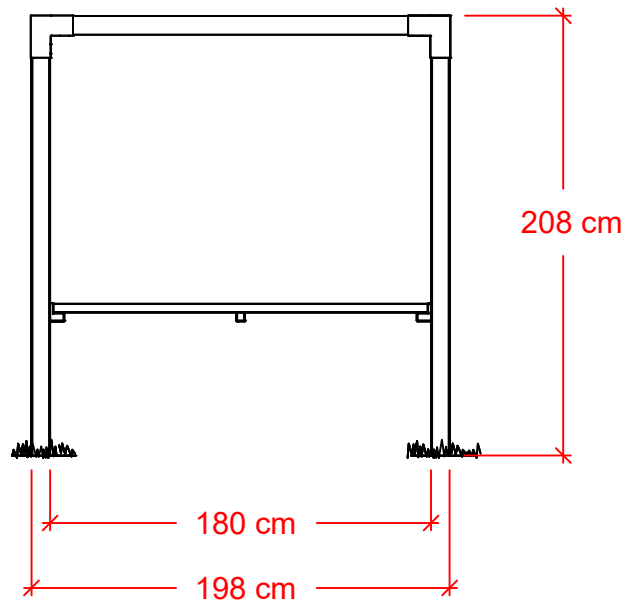

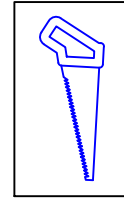
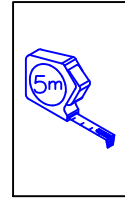
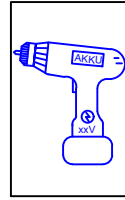
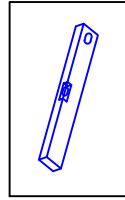
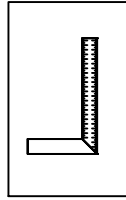
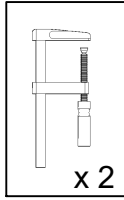
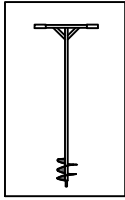
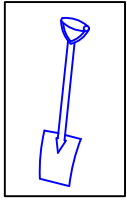

# 179079-15



4 x 20369-15 (2680 mm)

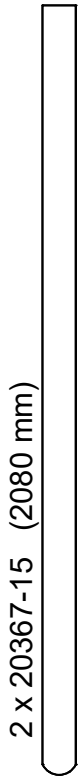

2 x 20367-15 (2080 mm)



2 x 17956-15 (900 mm)

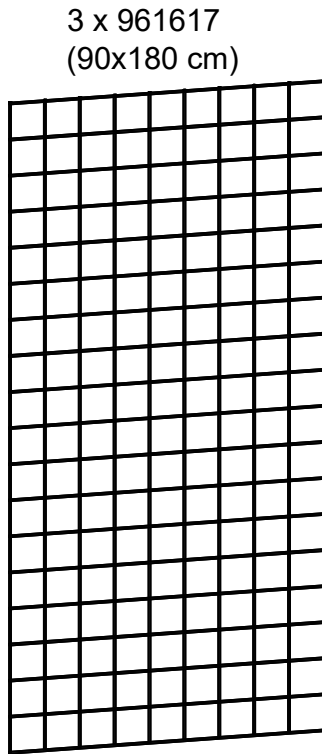

3 x 961617 (90x180 cm)

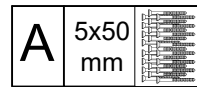

2 x 17518-15

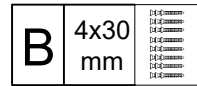

2 x 17516-15

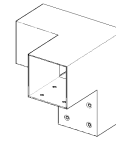

4 x 17971-15

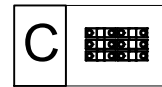

3 x 0247-15

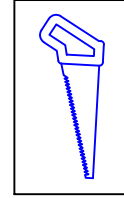
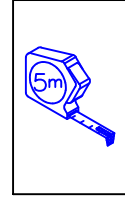
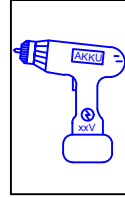
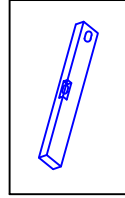
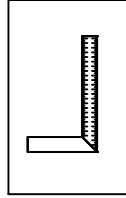
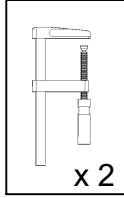
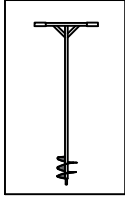
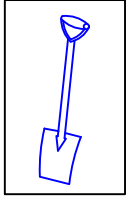

# 179080-15

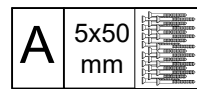
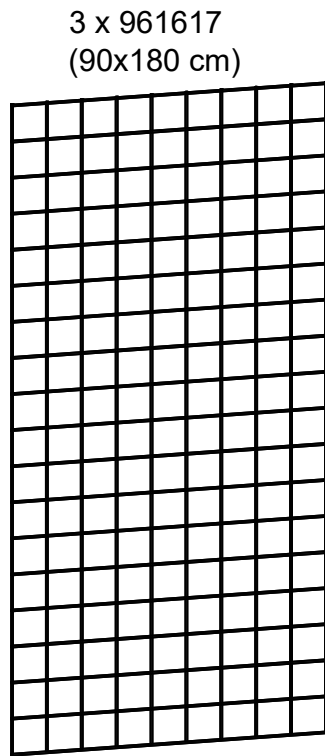
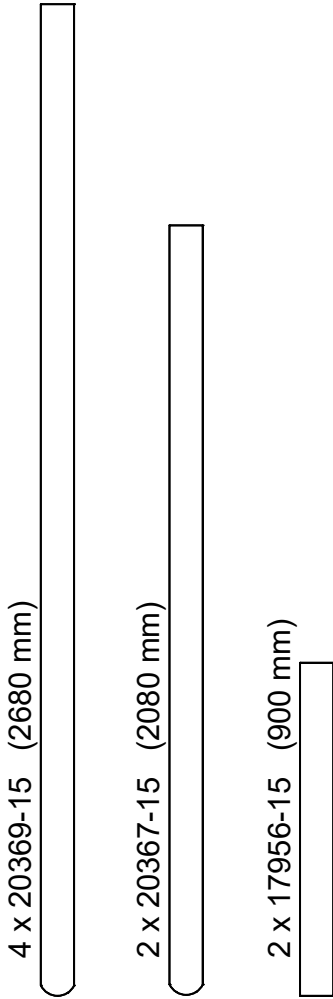

2 x 17518-15

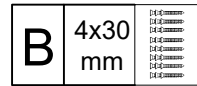

2 x 17516-15

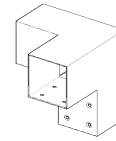

4 x 17971-15

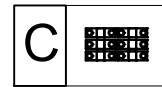

3 x 0247-15

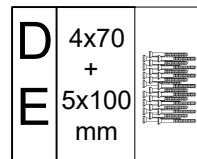

1 x 185401

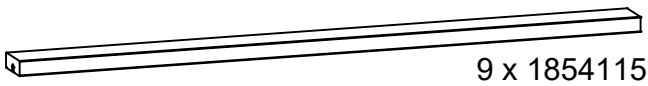

DK: Ved lerjord anbefaler vi 10 cm småsten i bunden som dræn. Jorden omkring stolpen, stemples til med en lægte eller lignende.

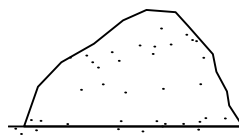
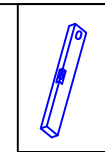
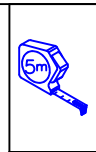
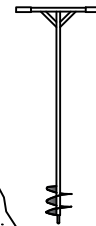
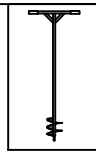

DE: In Tonböden empfehlen wir 10 cm Kies in den Boden als Drainage. Den Boden um die Pfosten mit einer Latte oder Ähnlichen feststampfen.

69 cm

69 cm

småsten / Kies / cailloux

S: För lerjord rekommenderar vi 10 cm småsten i botten som dränering. Jorden runt stolpen stansas till med en läkt eller liknande.

F: Pour un sol argileux, nous recommandons 10 cm de graviers au fond pour garantir le drainage. Le sol autour du poteau doit être damé avec une règle ou un autre outil similaire.

DK: Jorden stemples til, når alle dele er monteret og skruet fast. (Stolper, overligger, beslag og rio-net)

DE: Nachdem alle Teile (Pfosten, Träger, Beschläge und Spalier) montiert sind soll der Boden um die Pfosten gut festgestampft werden.

S: Jorden stansas till när alla delar är monterade och fastskruvade. (Stolpar, överliggare, fästen och rionät)

F: Domez le sol une fois que toutes les pièces sont montées et vissées. (Poteaux, linteaux, fixations et filet rio)

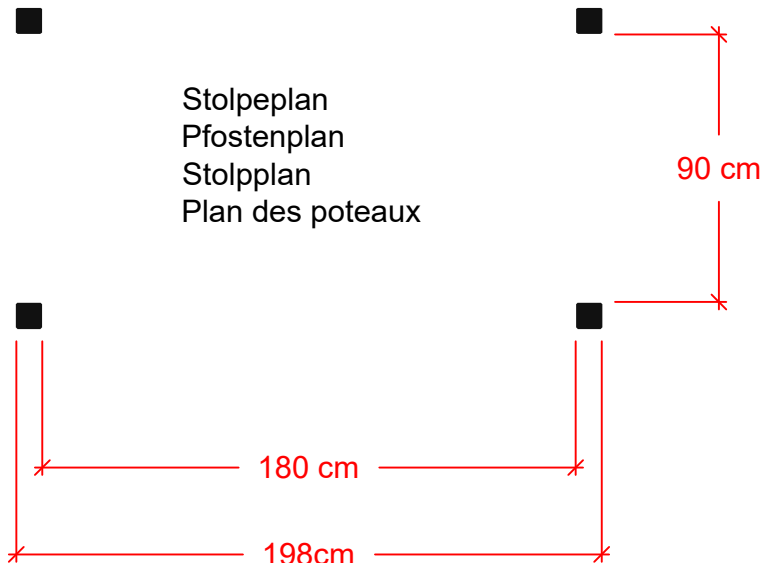

DK: 20367-15 stolpe/overligger skal tilpasses - Se side x.

DE: 20367-15 Pfosten/Querträger müssen angepasst werden - Siehe Seite x.

S: 20367-15 stolpe/räcke ska anpassas - Se sidan x.

F: Le poteau 20367-15 doit être adapté - Voir page x.

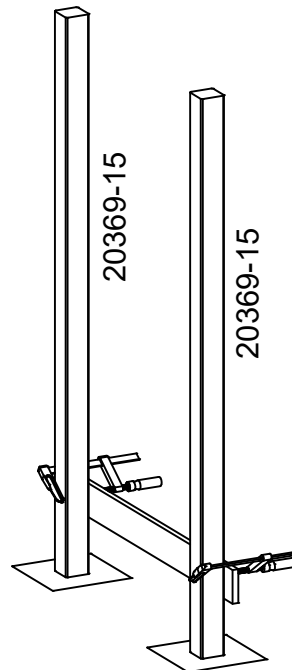
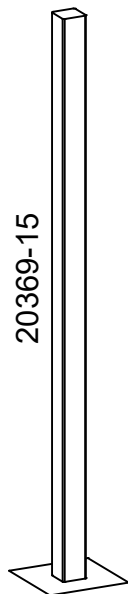
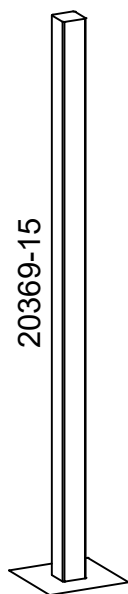
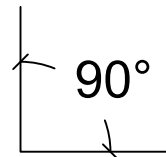
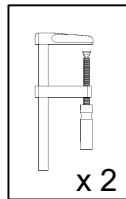
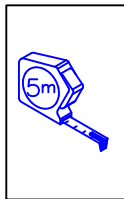
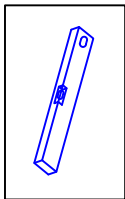
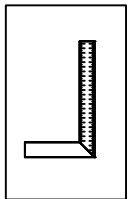
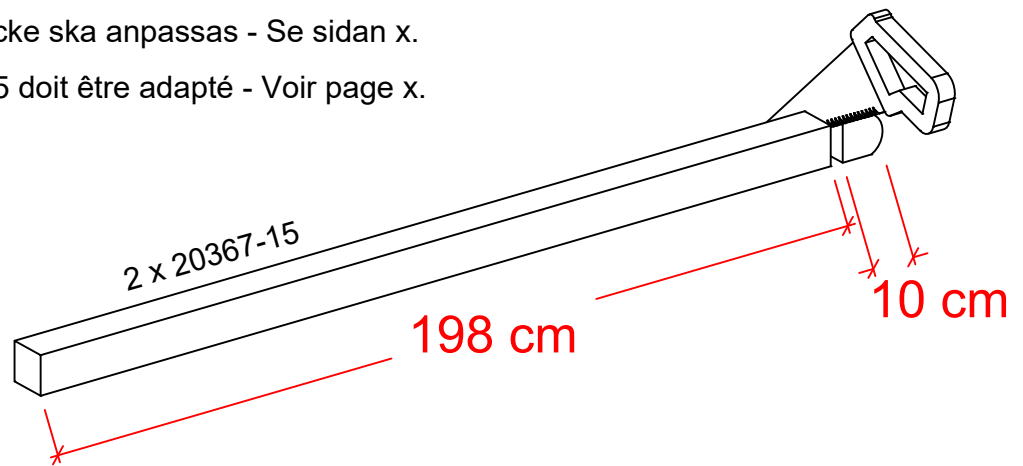
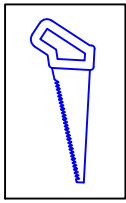

DK: Et bræt fastgjort med skruetvinger, kan bruges til at holde afstand og styring af stolper.

DE: Möglicherweise, Ein mit Schraubzwingen befestigtes Brett, kann zum Abstandhalten verwendet werden und Kontrolle der Posten.

S: Ev. en bräda fixerad med skruetvingar kan användas för att hålla avstånd och styra stolparna.

F: Si nécessaire, utilisez une planche fixée avec des pinces pour vérifier la distance et ajuster les poteaux.

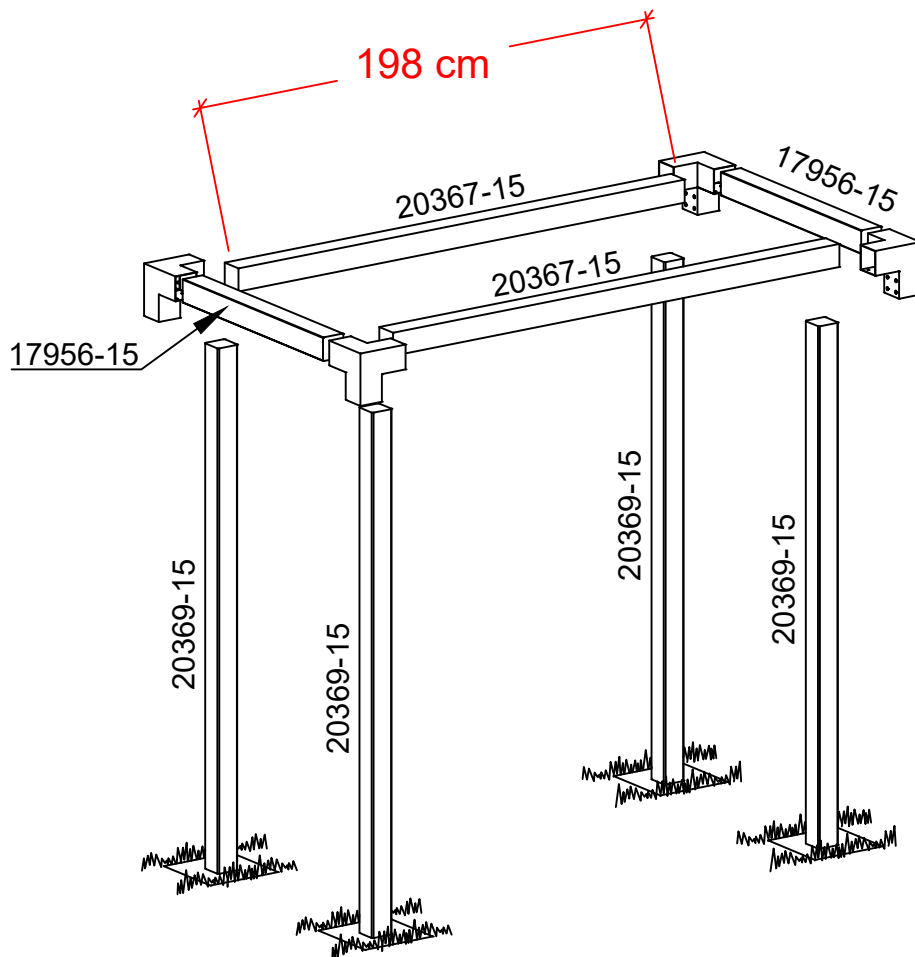
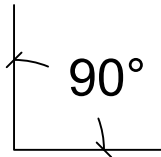
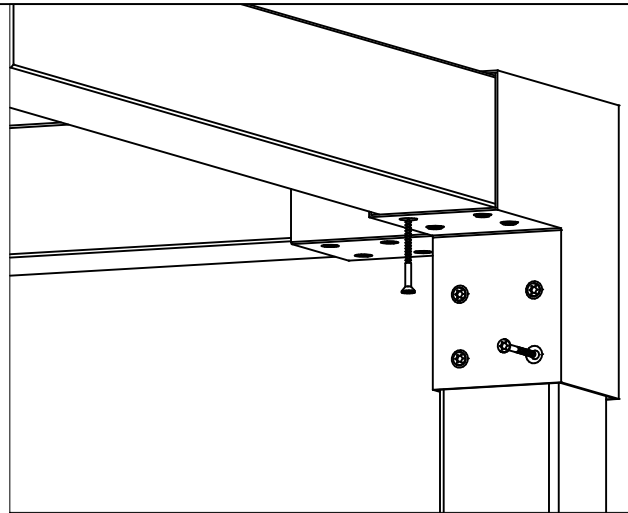
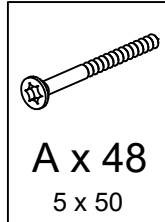
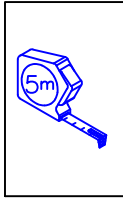

DK: Skruer strammes til, når ALLE dele er færdig samlet.

DE: Ziehen Sie die Schrauben fest, wenn ALLE Teile zusammengebaut sind.

S: Skruvarna dras åt när ALLA delar är monterade.

F: Serrez les vis une fois que TOUTES les pièces sont assemblées.

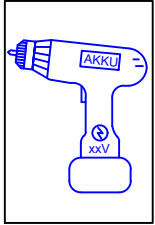
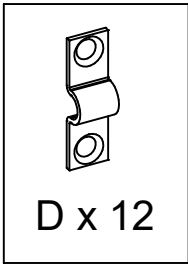
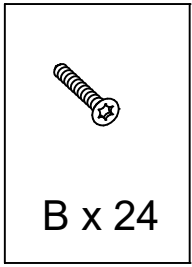

x 2

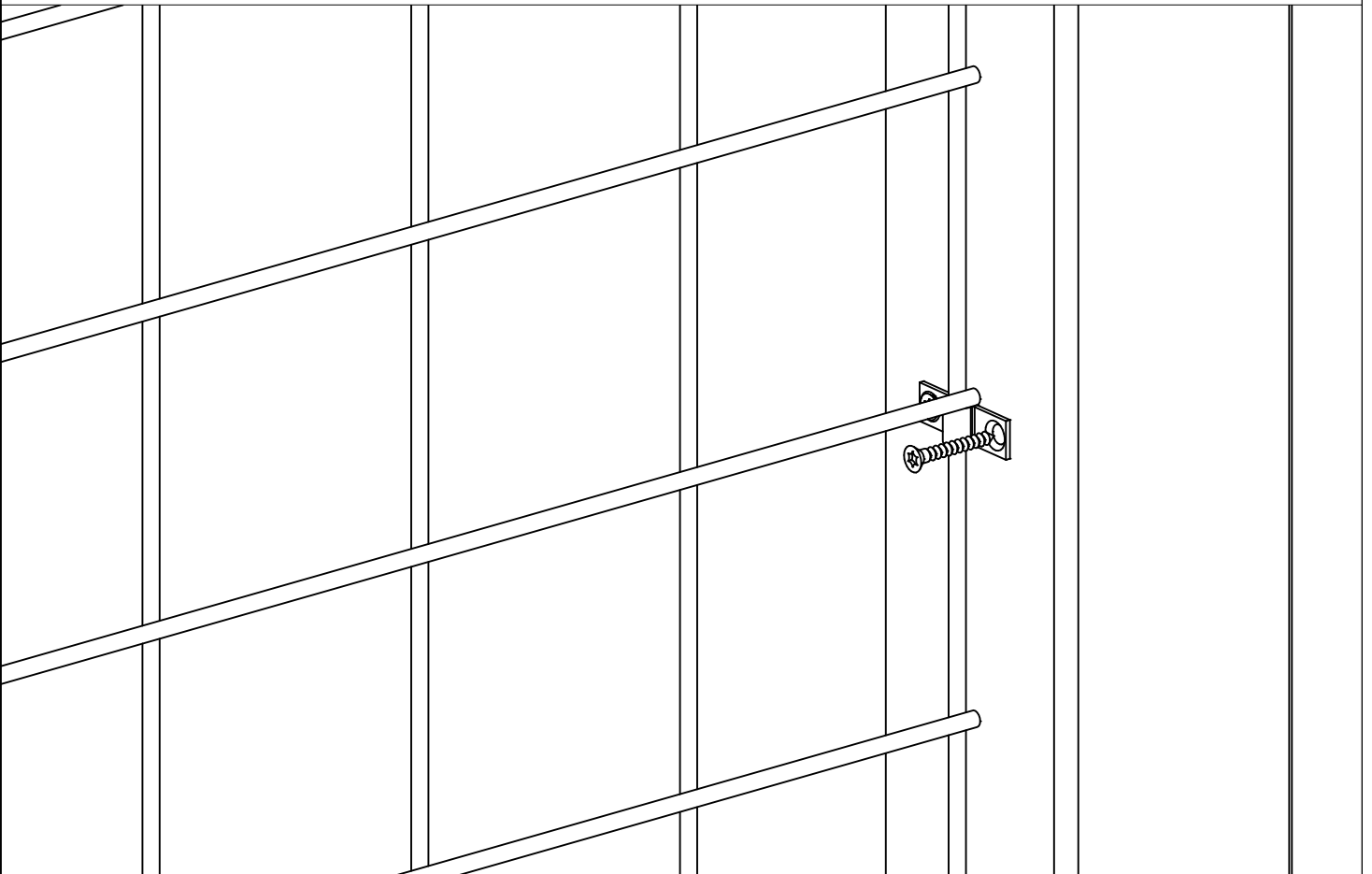
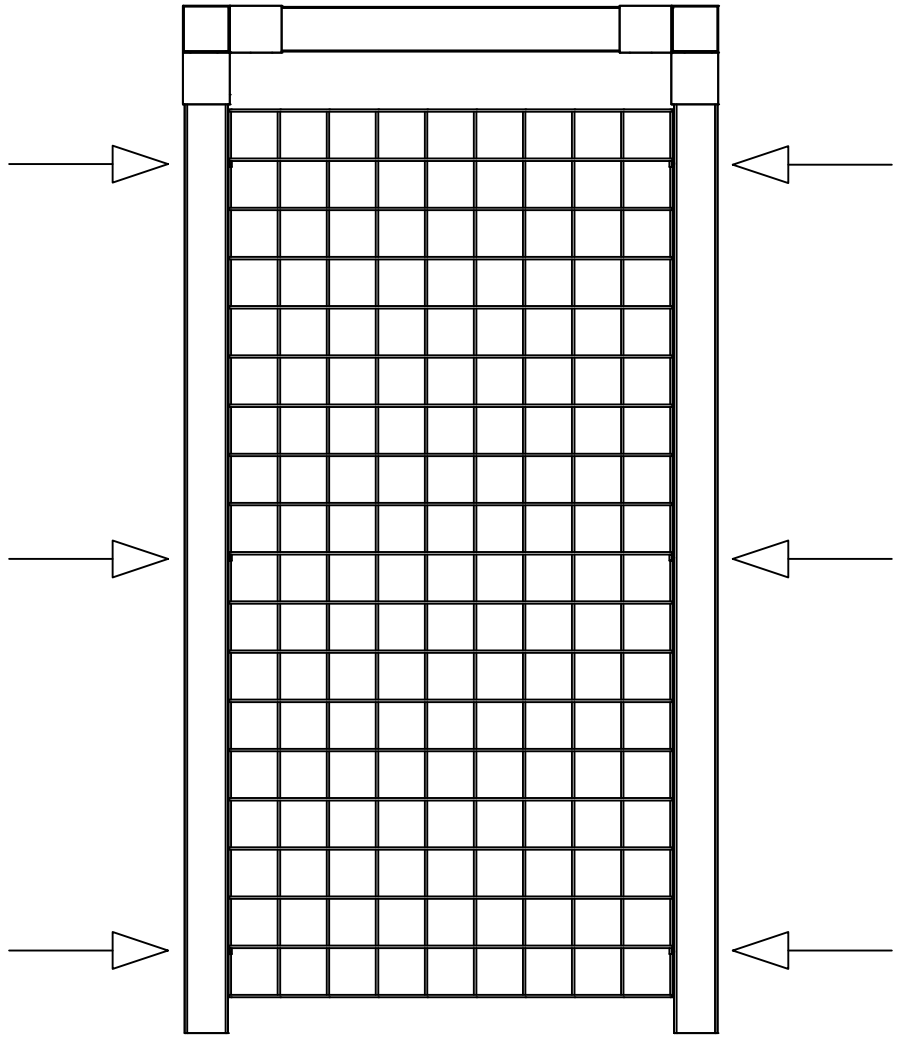

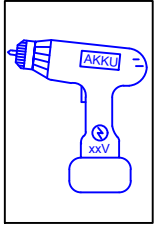
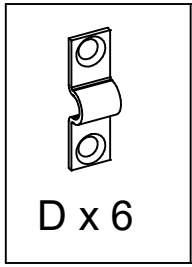

x 1

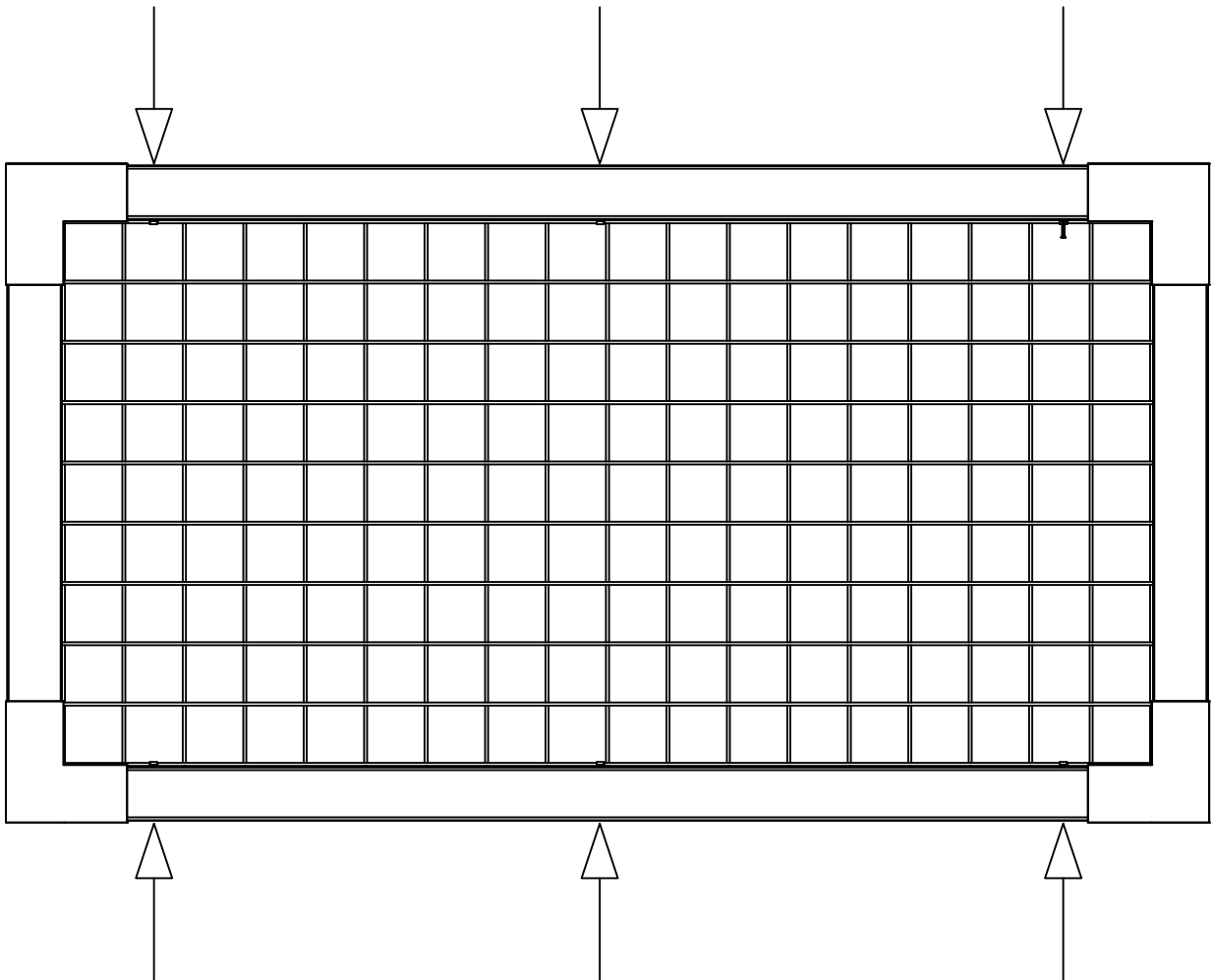
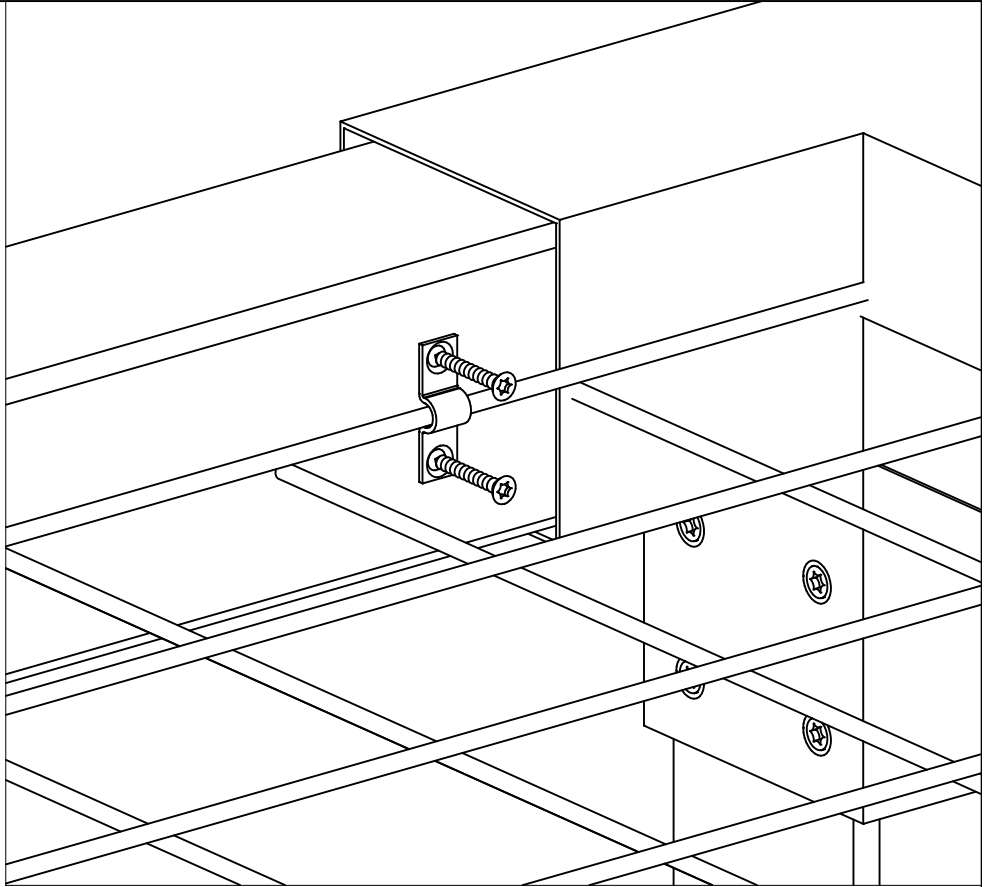



179079-15

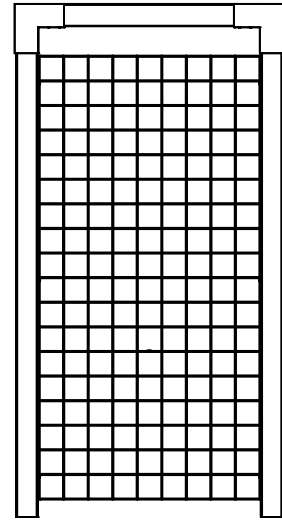
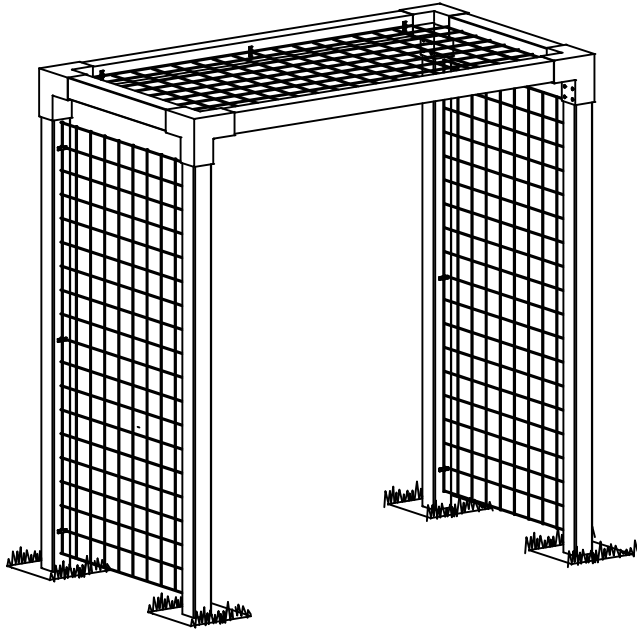

179080-15

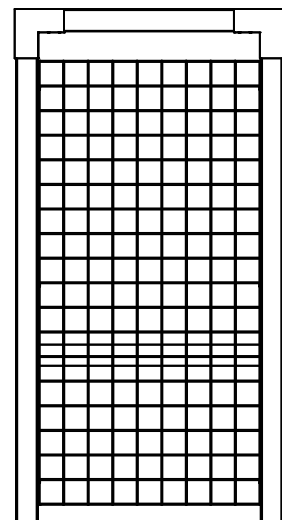
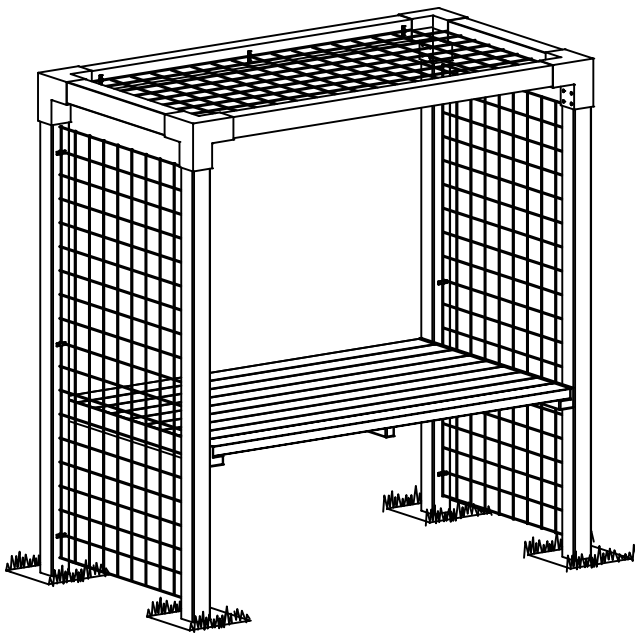

DK: Se side 10+11.

DE: Siehe Seiten 10+11.

S: Se sidorna 10+11.

F: Voir pages 10+11.

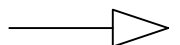

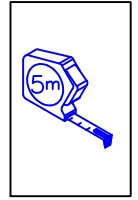
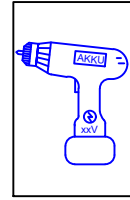
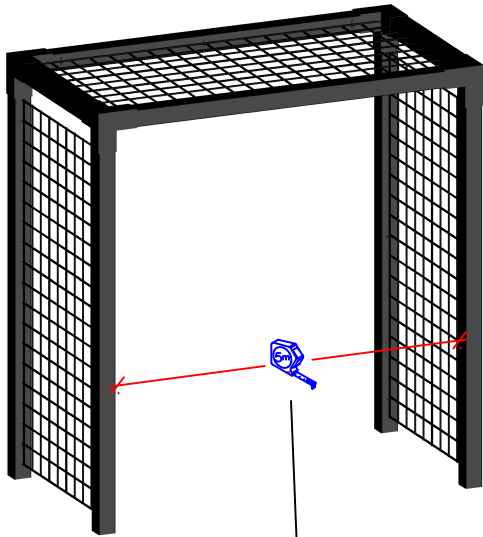

Viktigt - Wichtig - Viktig..!

- Træplanker forbores stille og roligt (3 mm)
- Holzplanken vorbohren vorsichtig und langsam. (3 mm)
- Träplankor förborra lugnt och försiktigt (3 mm)
- Planches de bois pré-percer soigneusement. (3 mm)

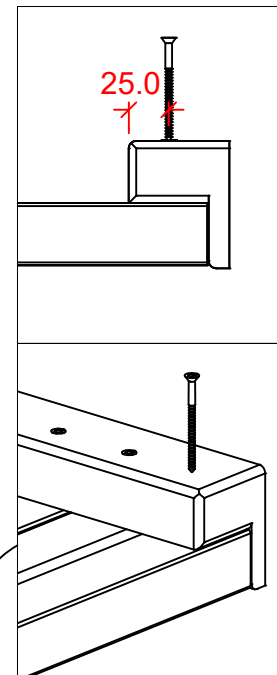
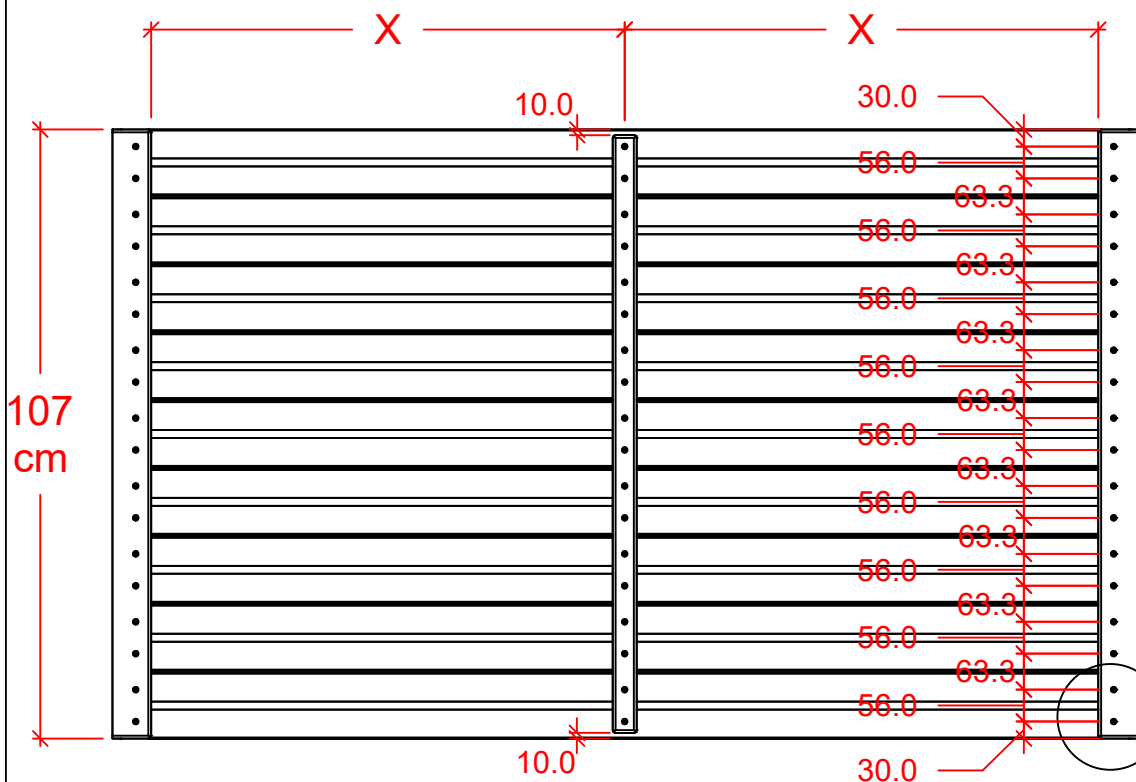
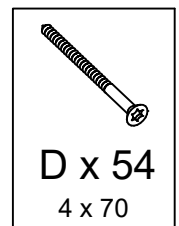
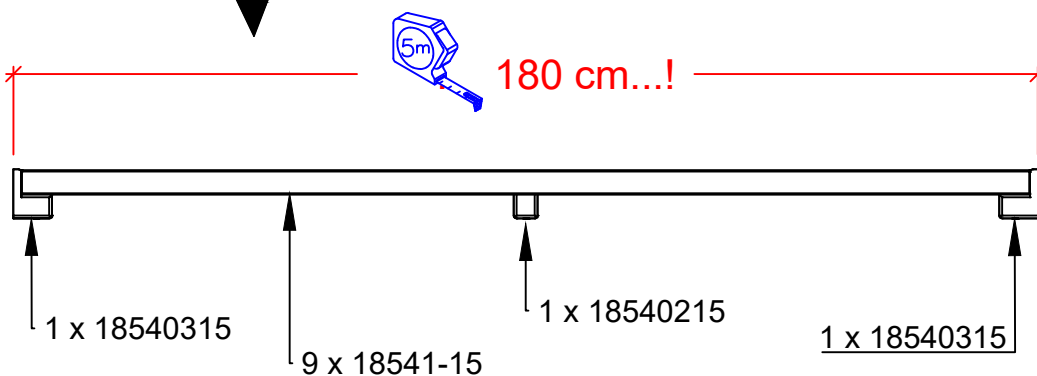

DK: Yderste brædder helt ud til kanten, øvrige brædder fordeles jævnt (3-4 mm mellemrum).

DE: Äußerste Bretter bis zum Rand, andere Bretter gleichmäßig verteilt (3-4 mm Spalt).

S: Yttersta brädor ända ut till kanten, övriga brädor fördelas jämnt (3-4 mm mellanrum).

F: Les planches les plus à l'extérieur jusqu'au bord, les autres planches sont réparties uniformément (3-4 mm d'écart).

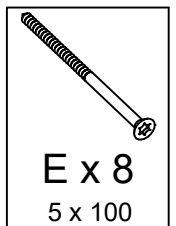
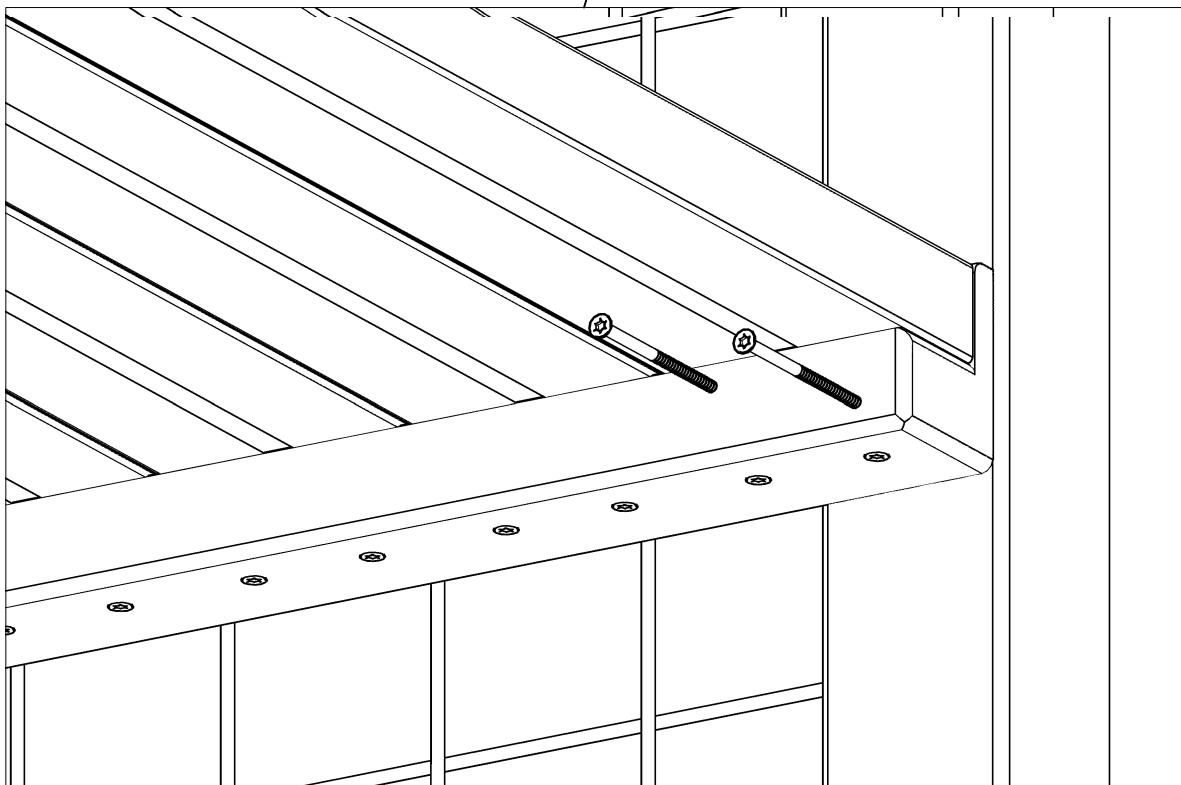
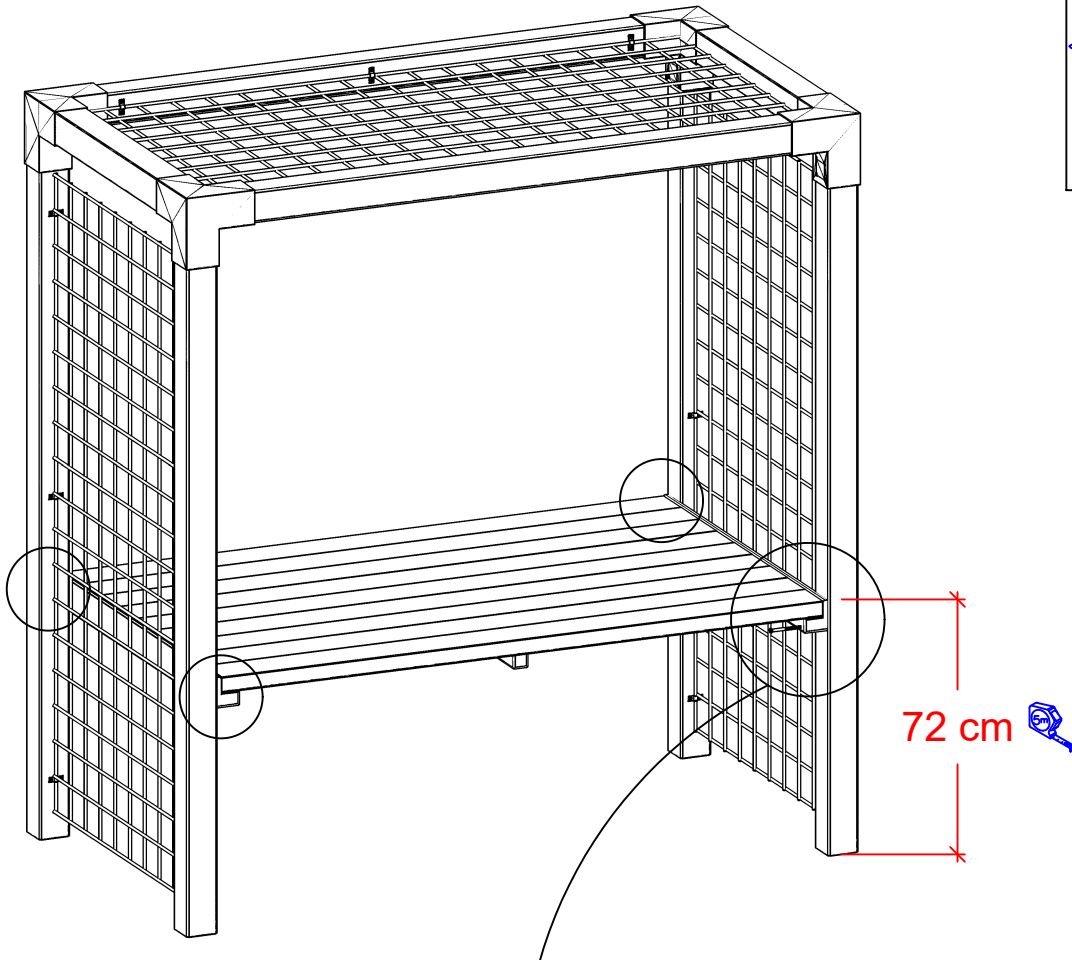
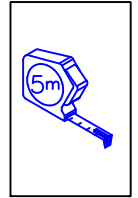
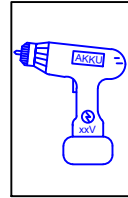

Viktigt - Wichtig - Viktig..!

- Forbores stille og roligt (3 mm)
- Vorbohren vorsichtig und langsam. (3 mm)
- Förborra lugnt och försiktigt (3 mm)
- Pré-percez tranquillement. (3 mm)

## NACHBEHANDLUNG UND PFLEGE

Holz ist ein Naturprodukt, das vom Wind und Wetter beeinflusst wird – dagegen können wir nichts tun. Aber wir können Ihnen einige gute Tipps geben, mit denen Sie die Lebensdauer Ihres PLUS - Produktes verlängern können.

Unsere Faustregel ist: Alle Holzprodukte die Sie bei uns erwerben, müssen nachbehandelt werden!

## PULVERLACKIERTE TEILE

Die Stahlteile werden vor der Pulverbeschichtung feuerverzinkt, wodurch die Stahlteile vor Rost geschützt sind.

Die anschließende Pulverbeschichtung verleiht den Teilen einen stilechten Ausdruck.

Es kann zu unterschiedlichen Rauheiten in der Oberfläche kommen, die von der Feuerverzinkung unter der Pulverisierung stammen. Die Teile können nach Bedarf mit einem Tuch und gewöhnlichem Seifenwasser gereinigt werden.